

Cliff Hanson
11-1-63

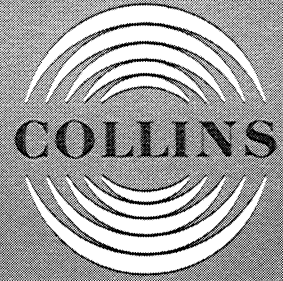

GENERAL CATALOG

Components Division / Collins Radio Company, Newport Beach, California

Bulletin 1031

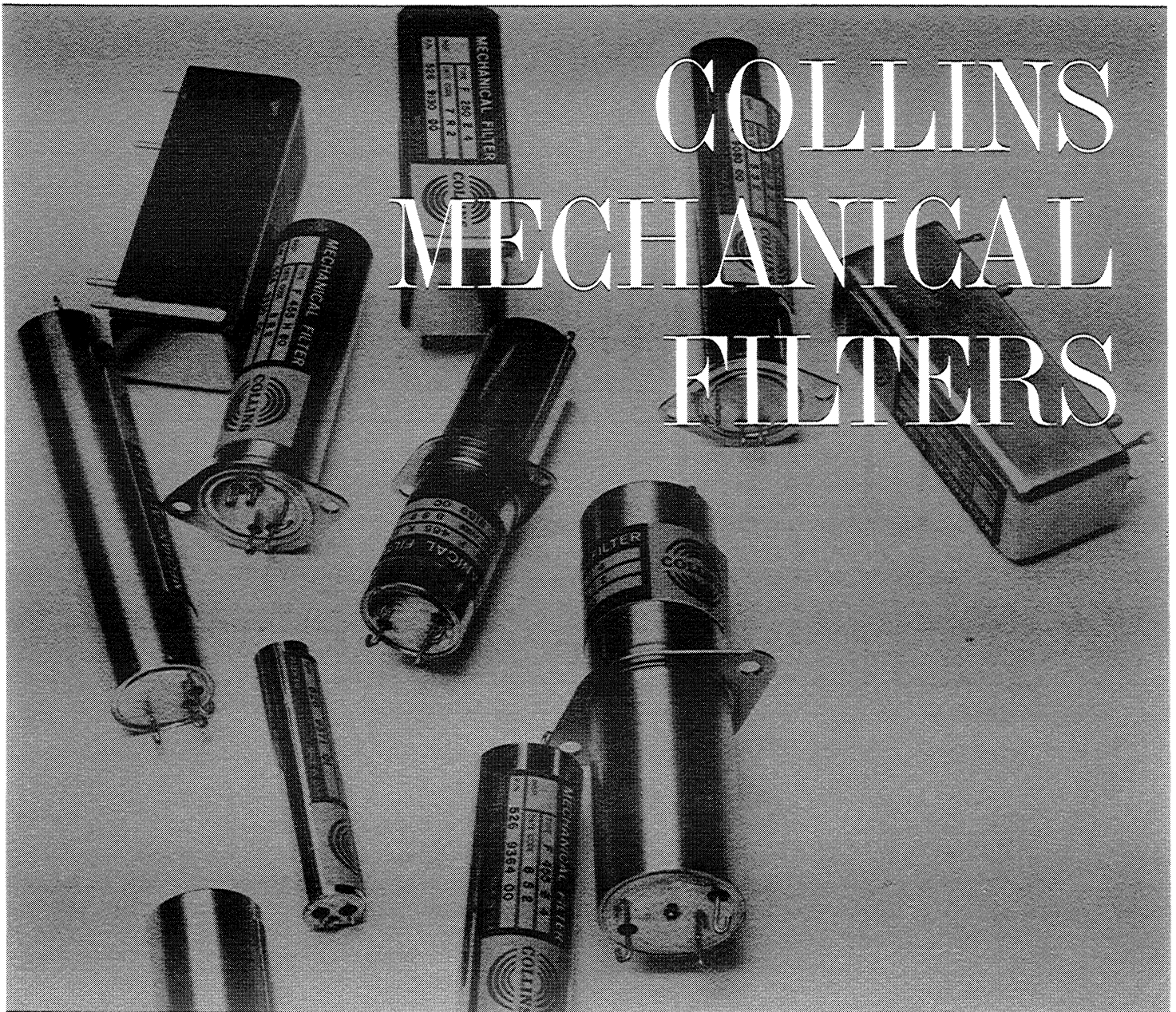

MECHANICAL FILTER FREQUENCY-BANDWIDTH SPECTRUM

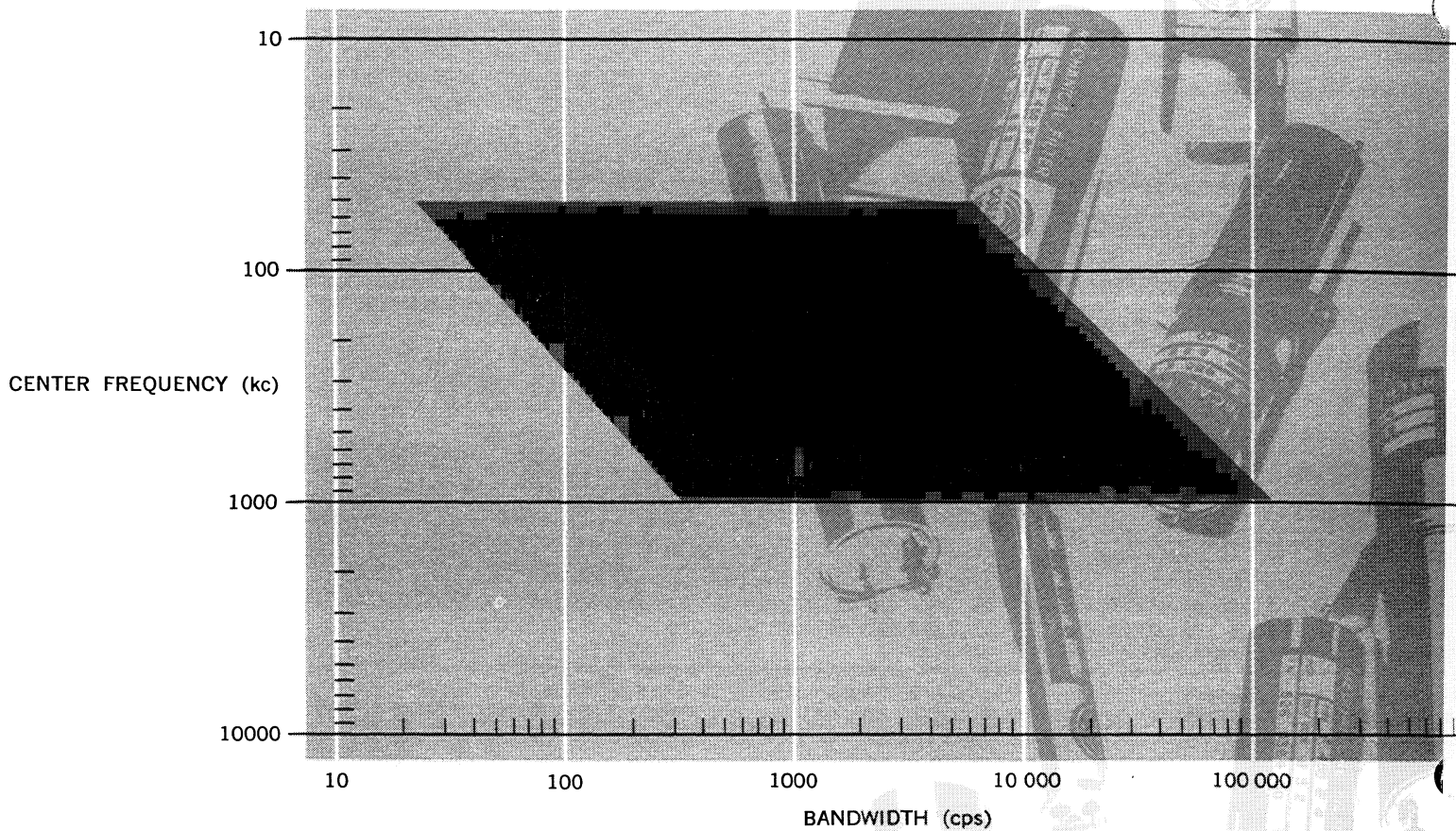

THE TRANSDUCER, which converts electrical and mechanical energy, is a magnetostrictive device based on the principle that certain materials elongate or shorten when in the presence of a magnetic field. When an electrical signal is sent through a coil which contains the magnetostrictive material as the core, the electrical oscillation will be converted into a mechanical oscillation. The mechanical oscillation can then be used to drive the mechanical elements of the Filter. In addition to electrical and mechanical conversion, the transducer also provides proper termination for the mechanical network.

FROM THE ELECTRICAL EQUIPMENT circuit it is seen that the center frequency of the Mechanical Filter is determined by the metal discs, which are represented by a series resonant circuit, $L_1 C_1$. (Filters with center frequencies between 60 kc and 600 kc are being manufactured. This by no means indicates limitations, but is merely the area of current design concentration, see above graph.) Since each disc represents a series resonant circuit, increasing the number of discs increases skirt selectivity of the Filter. Skirt selectivity is specified as shape factor, which is the ratio (bandwidth 60 db below peak) / (bandwidth 6 db below peak).

IN THE EQUIVALENT CIRCUIT, the coupling capacitors, C_2 , represent the rods which couple the discs. By varying the mechanical coupling between the discs, i.e., making the coupling rods larger or smaller, the bandwidth of the Filter is varied. Because the bandwidth varies approximately as the total area of the coupling wires, the bandwidth can be increased by either using larger or more coupling rods. Standard available bandwidths range from 500 cps to 50 kc, and special units have been built with bandwidths as narrow as 30 cps and as wide as 60 kc.

CURRENT IMPROVEMENTS. Considerable progress is being made in improving selectivity and other performance characteristics of mechanical filters. The use of ferrite transducer elements, for example, has reduced insertion loss and passband ripple while making practical the cascading of various filter types as a means of improving selectivity. Magnetostrictive ferrites used in transducers have also made possible greater fractional bandwidths and reduction in microphonic responses.

Careful grading and heat treatment of the nickel-alloy disc resonant elements has resulted in temperature coefficients of the discs being reduced to as low as one part in one million per degree Centigrade over a 100 degree range.

Other means of increasing selectivity in general and of producing more effective filters for single sideband application are being investigated. These include cascading two filters together and intentional distortion of the nodal pattern of the discs.

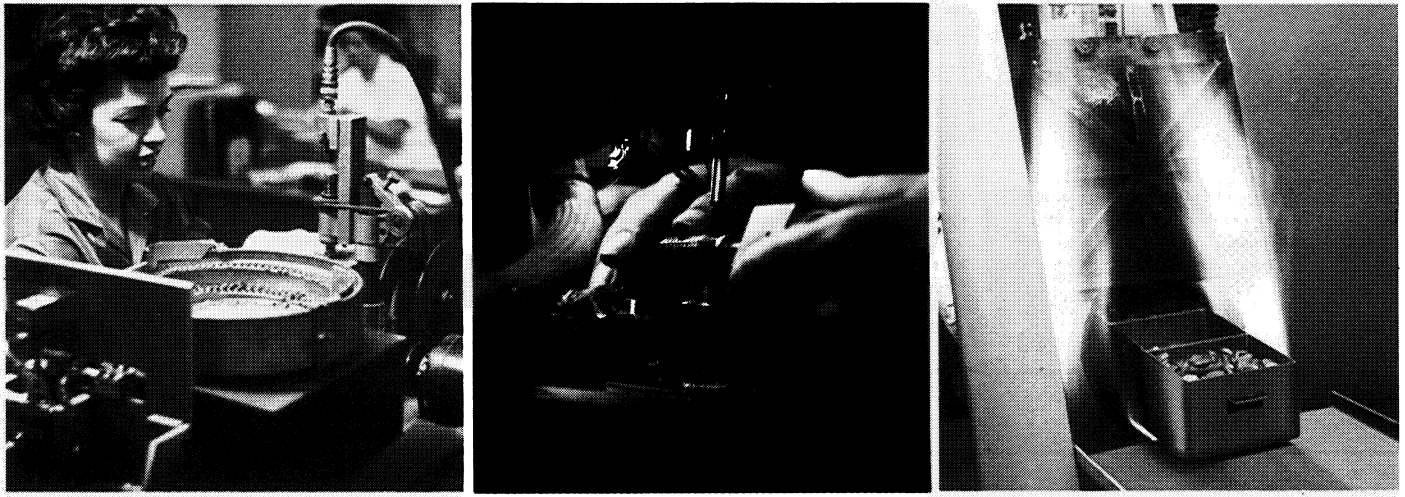

APPLICATIONS FOR THE WIDE RANGE of standard Filters include high performance transmitting and receiving equipment, multiplexing equipment, missile guidance systems, frequency synthesizers, Doppler radar, data transmission systems, precision navigation equipment and spectrum analyzers. Many advances in frequency spectrum conservation have been made possible by Mechanical Filters and their superior selectivity characteristics. Such techniques are split-channel reception, improved methods of amplitude modulation and single sideband communication and superior detection methods for data transmission systems.

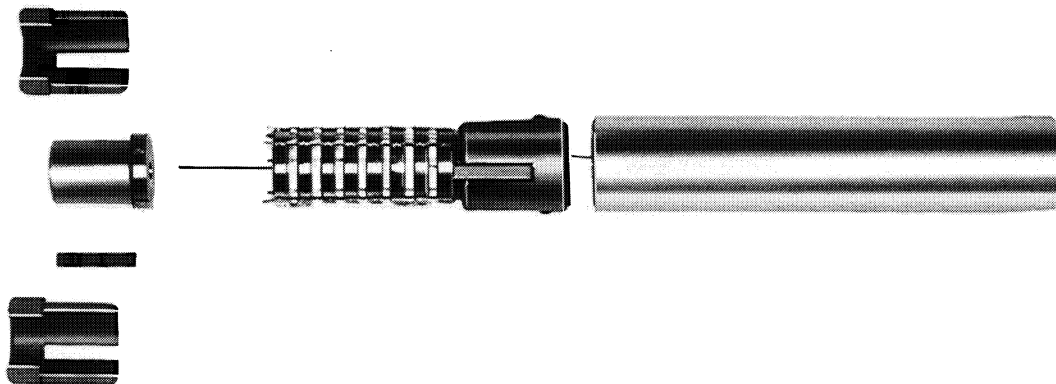

APPLICATION AND DESIGN CONSIDERATIONS

THE DESIGN OF CIRCUITS employing Mechanical Filters is relatively simple, since no special matching networks are normally required. Being internally terminated, the filters need only a high-resistance termination (50,000 ohms or greater) at either end together with the capacity (approximately 130 pf) required to resonate filter input and output at the center frequency.

THIS HIGH RESISTANCE is readily obtained by driving the Filter with a pentode tube (effectively a constant current generator) and terminating it into a vacuum tube grid. It was this usage that led to the use of the term "transfer impedance" in specifying the effect of a Mechanical Filter on the gain of a given circuit. The transfer impedance is the ratio of the input current to the output voltage, so the over-all gain of an amplifier stage with a Mechanical Filter following the amplifier tube is simply equal to the transconductance of the tube times the transfer impedance.

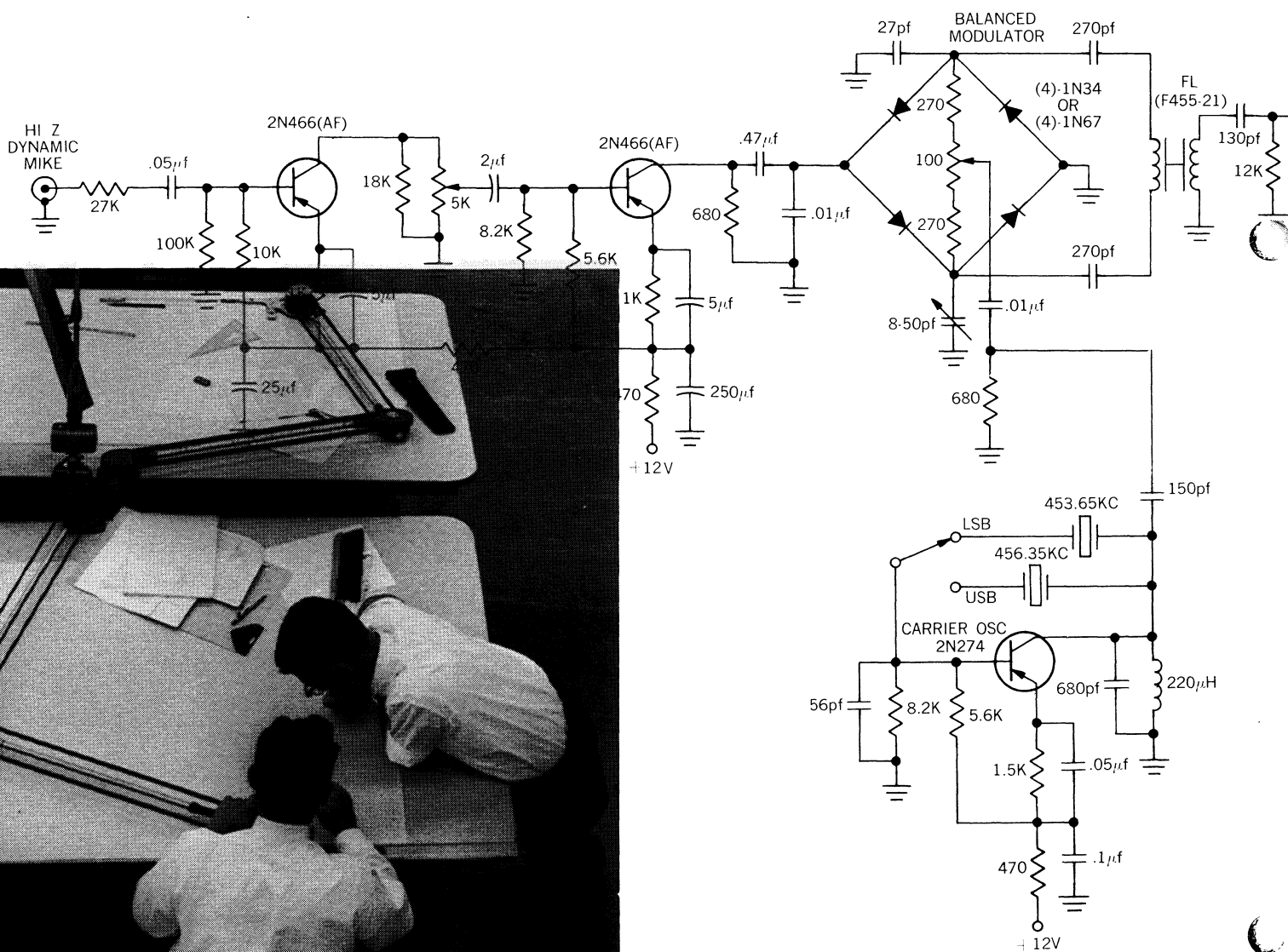

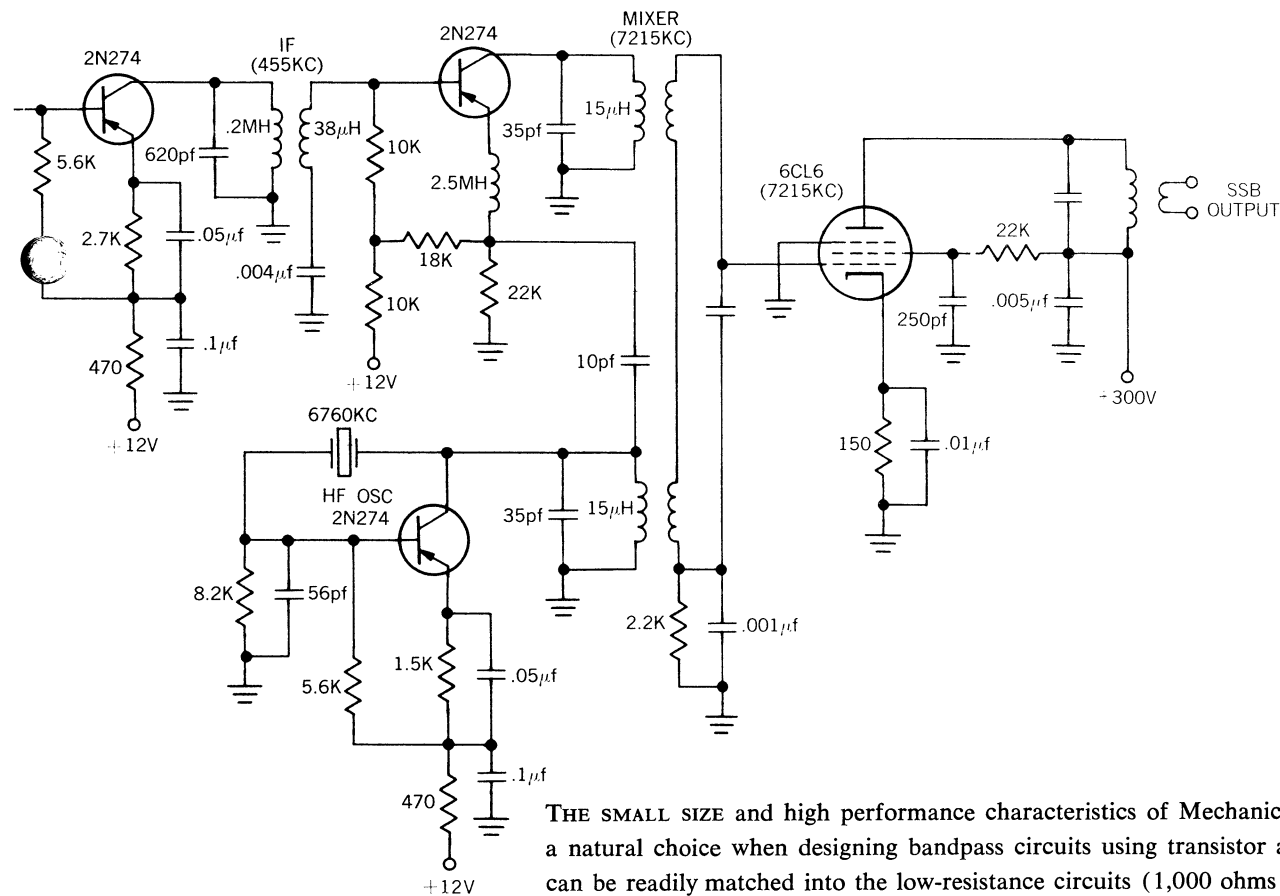
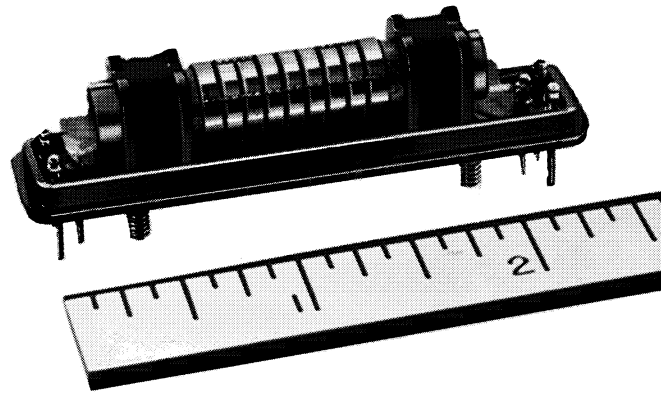
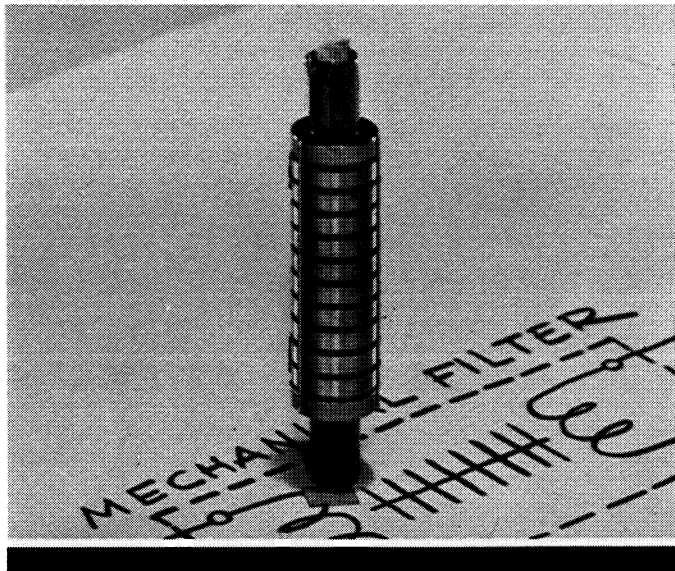

S.S.B. EXCITER BALANCED MODULATOR
USING COLLINS MECHANICAL FILTER

THE SMALL SIZE and high performance characteristics of Mechanical Filters make them a natural choice when designing bandpass circuits using transistor amplifiers. The filters can be readily matched into the low-resistance circuits (1,000 ohms or less) encountered with transistors by using a series resonant termination. The lowest value of impedance that can be matched is determined by the extent to which the stray capacity across the Filter can be minimized. This impedance will be in the order of magnitude normally encountered with grounded emitter amplifiers. In some applications, such as balanced modulators, it is desirable to terminate the Filter into a balanced load. For this reason, each set of terminals on the Filter is balanced to ground, eliminating the need for isolation transformers or amplifiers in circuits of this type.

WHEN MECHANICAL FILTERS ARE USED IN BANDPASS circuits there are a number of precautions that must be taken if full advantage is to be derived from its steep skirt rejection capabilities: For example, the use of short wires between the Filter terminals and the termination circuitry; effective shielding between the input and the output, and the use of a common ground for the Filter input, shield and output. These precautions prevent the input signal from partially bypassing the Filter through inductive or capacitive coupling or ground loops.

SINGLE SIDEBAND APPLICATIONS. Collins Mechanical Filters have found great acceptance in single sideband transmitter and receiver applications because they provide the flat-topped passband and steep selectivity needed to reject the unwanted sideband and closely adjacent channels in the receiver.

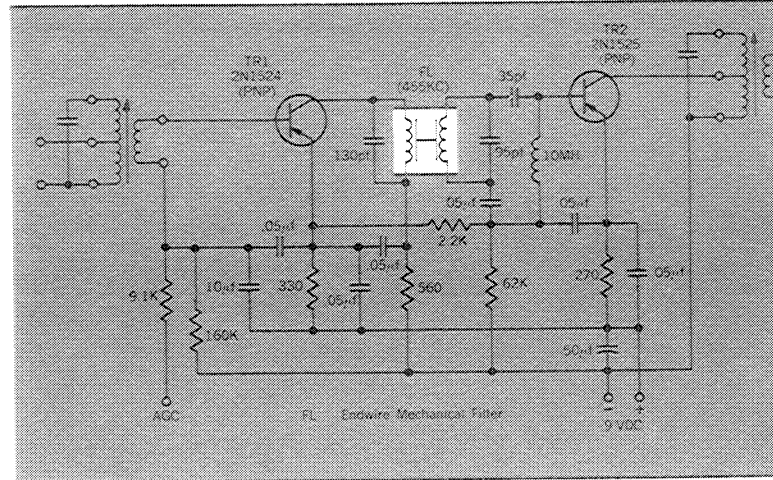
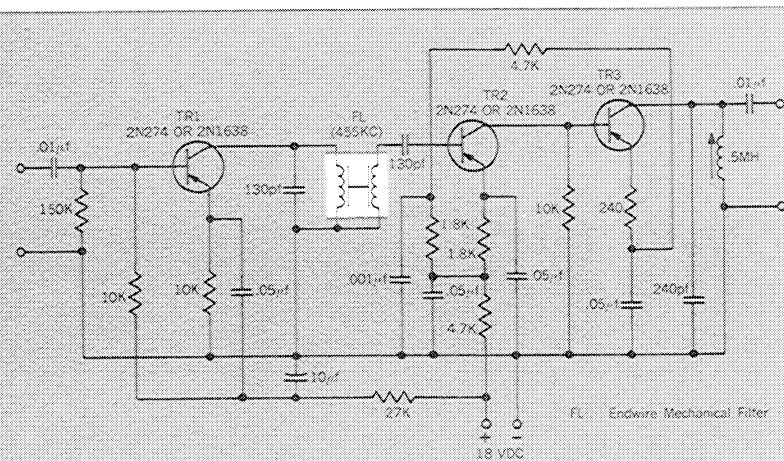
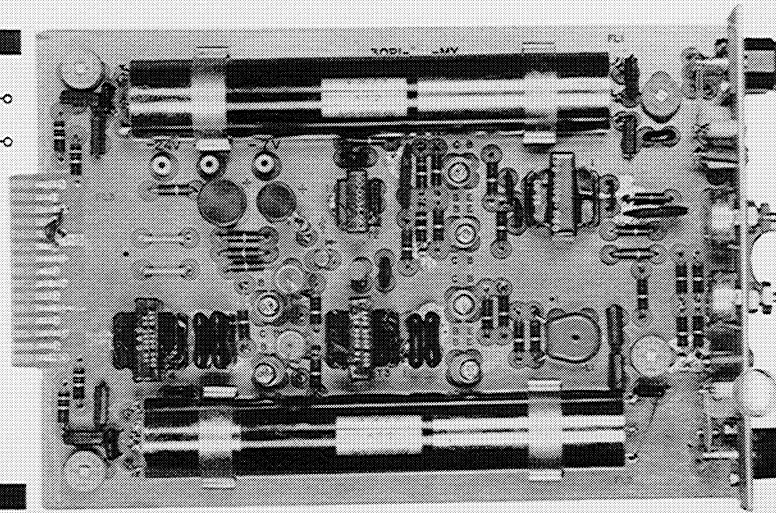
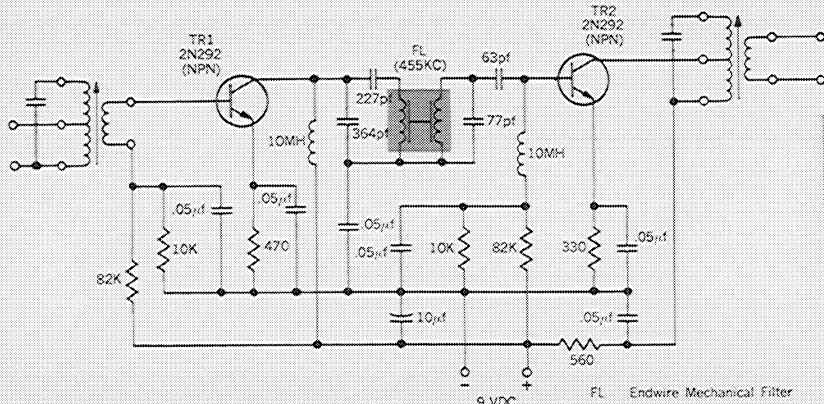

TRANSISTOR I.F. AMPLIFIERS. Another useful area of application for mechanical filters is in transistor I.F. amplifier stages. In these circuits, the mechanical filter can substantially improve selectivity and gain and at the same time provide a simpler, more compact and reliable unit. Several typical schematics are shown.

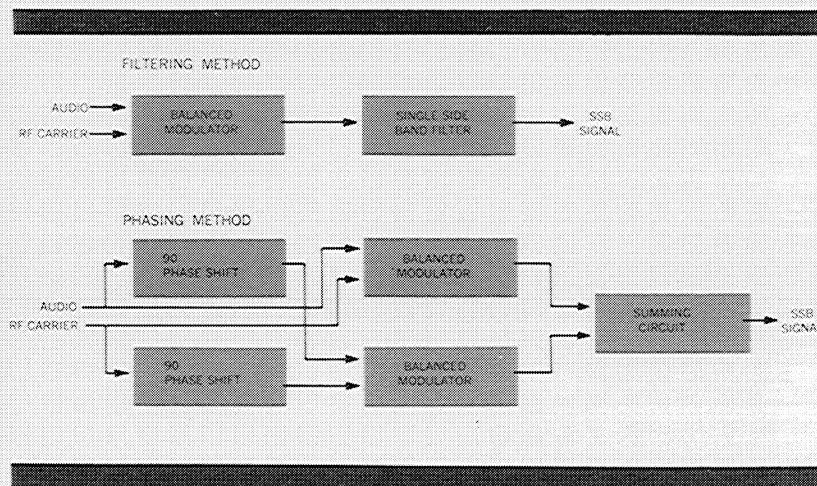
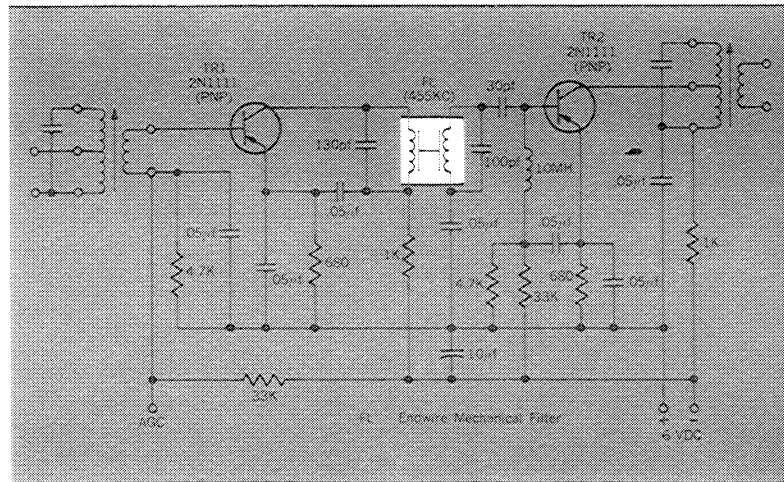
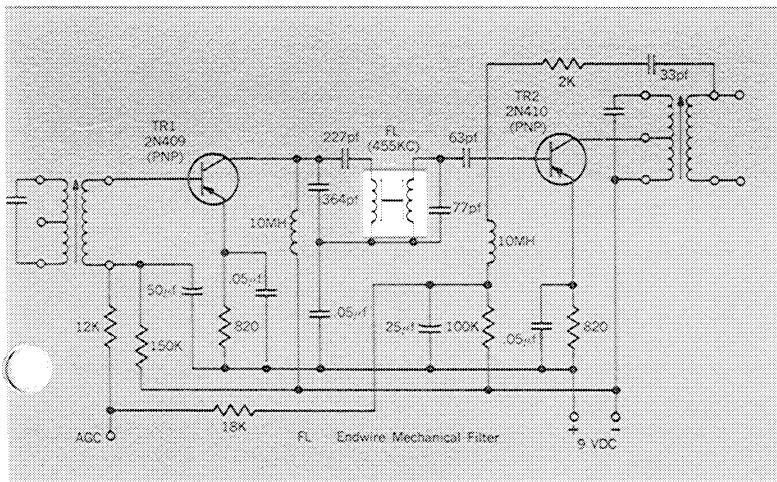
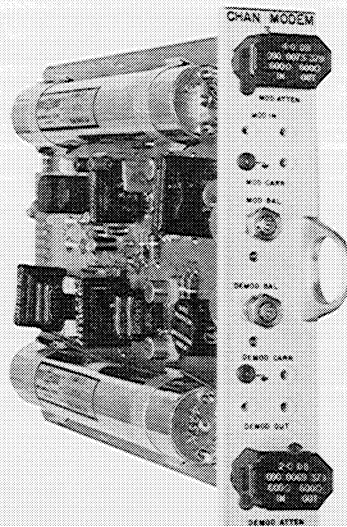

GENERATING THE SINGLE SIDEBAND. In using a mechanical filter to produce a single sideband signal, the first step is elimination of the carrier by cancellation, usually with a balanced modulator. In the block diagram shown, the RF signal is generated at low frequencies and after the carrier has been eliminated a sharp filter is used to select one of the sidebands. The signal is then heterodyned up to the desired frequency.

If ordinary LC circuits and filters are used, this must be done at very low frequencies and the required Q 's and stabilities are difficult to attain. The relative simplicity of the filter method compared to the phasing method can readily be seen in the diagram shown.

MECHANICAL FILTERS WITH FERRITE TRANSDUCERS

A NEW DESIGN DEVELOPMENT using magnetostrictive ferrite material has produced mechanical filters with greatly improved performance and many new applications.

After several years of development work, Collins engineers have successfully combined the mechanical filter's basic advantage of selectivity, simplicity, compactness, and reliability with the added strength to operate under shock and vibration of missile launching and other severe environmental conditions. In addition, ferrite-equipped filters demonstrate flatter passband response and lower transmission loss, two important characteristics which mean improved filter performance.

FERRITE USED IN TRANSDUCERS. The ferrite material in these new filters is employed in the magnetostrictive transducers, replacing the customary nickel-alloy rods. The transducers are the elements in the filter which convert the electrical signal applied to the filter to mechanical energy. This mechanical energy is transmitted through the resonant mechanical elements of the filter to an identical transducer where it is reconverted to electrical energy.

The ferrite material itself is the result of an extensive research program at Collins. Manufacturing techniques have been refined to the point where material with the desired electrical and mechanical properties is being produced in volume.

While the several hundred conventional filters in the Collins line are still ideal for most applications, this new development enables Collins engineers to design and produce mechanical filters to specifications previously considered difficult or impractical.

IMPROVED FILTER PERFORMANCE. One of the specific improvements in performance of mechanical filters equipped with ferrite transducers is a substantial decrease in transmission loss due to an increase in transducer efficiency. Magnetostrictive ferrites have very low eddy current loss and provide low loss termination for wideband filters. In general, transmission loss drops from the 8-12 db range in the nickel-alloy transducer filters to the 4-5 db range or less in the ferrite transducer filters.

Another important improvement is the peak-to-valley ratio, or passband ripple. In the new ferrite-equipped filters, this ratio is in the order of 1.5 db or less. This improvement is especially significant for phase or delay-sensitive applications such as data transmission systems.

FERRITE FILTERS CAN TAKE MORE PUNISHMENT. In general, ferrite-equipped filters can be used in more punishing environments, since the ferrite material gives more strength and rigidity to the transducer rods. Most military specifications regarding shocks and vibration are easily met. Some of the first ferrite filters produced are being used in missile guidance and telemetry systems.

CURRENT FERRITE FILTERS. At the present time several different mechanical filters for a variety of applications are being equipped with ferrite transducer rods.

Included in this group are two new filters designed especially for FM mobile radio receivers, a series of multiplex filters for microwave use, 3 kc single sideband filters and a series of narrow band filters for missile guidance and other space vehicle applications.

MOBILE FM RECEIVER FILTERS. One of the mobile radio filters, the F455YA-120, has application both as a component for original equipment and as a replacement part for improving performance of mobile FM receivers already in the field.

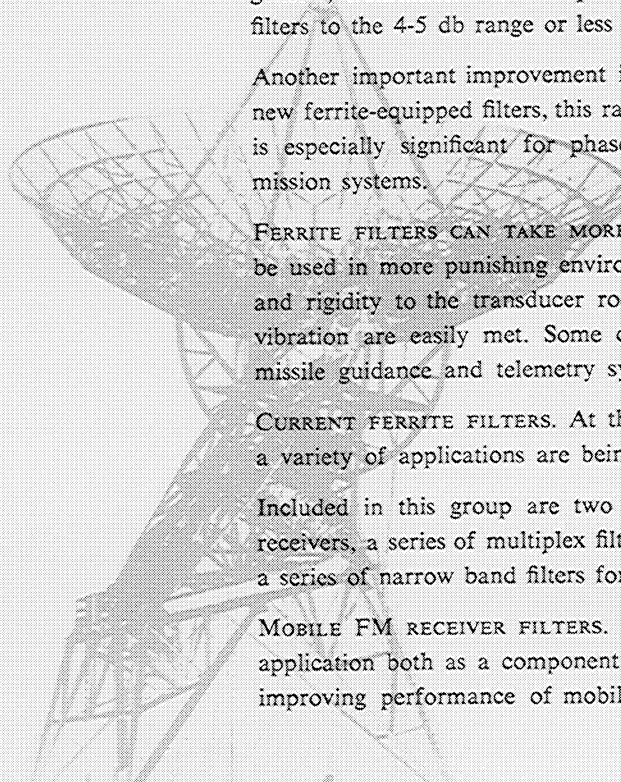
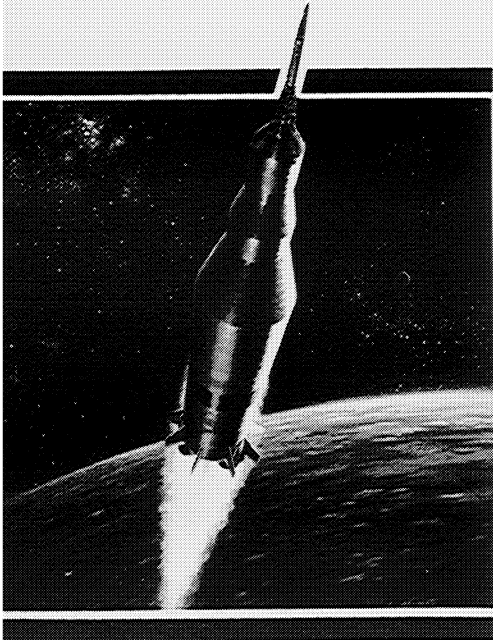

With this new filter, for example, operators of FM mobile communications equipment can quickly and easily modify their receivers to match systems using the ± 5 kc transmitter deviation specified under FCC split-channel rulings.

Because of its sharp cut-off characteristics (see illustration), the F455YA-120 will keep interference from adjacent channels to a minimum. The F455YA-120 has a center frequency of 455 kc and a passband of 12 kc.

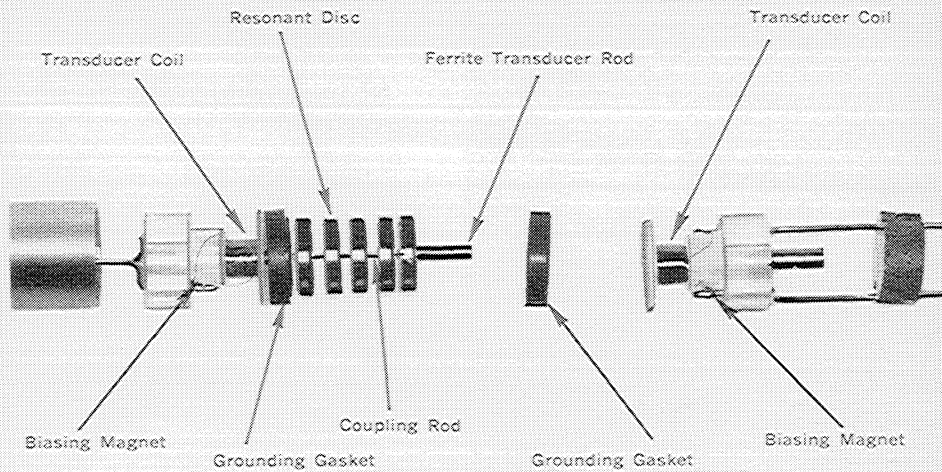
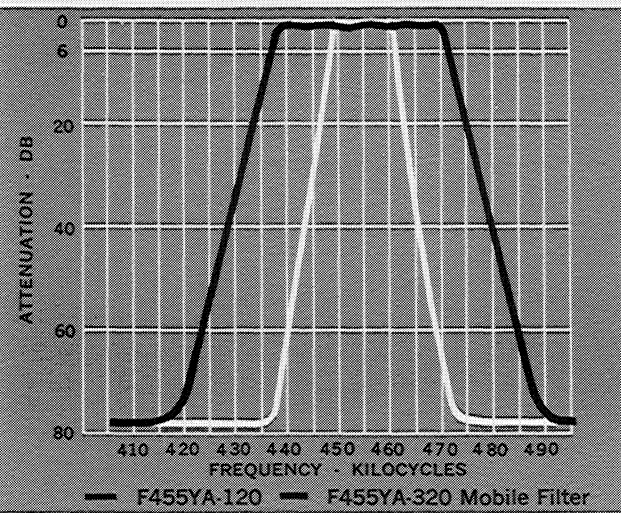

The other mobile filter, the F455YA-320, provides the same general performance benefits. It is particularly suited for wide band mobile receivers. Center frequency is 455 kc; passband is 32 kc. Both new filters are in a modified "Y" case, approximately 2 inches long and 1/2 inch in diameter.

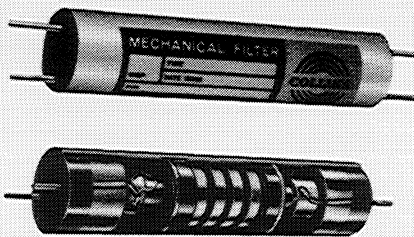

MISSILE GUIDANCE AND TELEMETRY FILTERS. In addition to increased strength due to the ferrite transducer rods, a new method of mounting the mechanical elements inside the case has made these new filters particularly suited to missile and space vehicle applications. Ability to withstand shock, G loading and sustained acceleration has improved substantially. Filters have been designed to withstand 100 G's and vibration rates of up to 2000 cycles per second.

MULTIPLEX FILTERS. A series of SSB channel filters for baseband generation in microwave applications are becoming available with ferrite transducers. The lower peak-to-valley ratio and the flatter passband response are especially significant in the microwave field, where amplitude and phase distortion must be held to a minimum.

APPLICATION OF FERRITE FILTERS. In general, there are four major areas of application where the improvements in performance provided by the ferrite-equipped mechanical filters are important.

IMPROVEMENT	APPLICATION	BENEFIT
Lower transmission loss	Data transmission systems, including frequency shift keying, phase-shift keying, pulse code telemetry. High frequency FM receivers, circuits with limited input power, low signal levels.	Better matching of filter to load. Less energy dissipated in filter, more energy delivered to load circuitry.
Lower peak-to-valley ratio	Delay, phase, and amplitude-sensitive systems, including above.	Flatter passband response, i.e., decreased ripple.
Better strength and rigidity	Missile, other applications subject to physical punishment.	Withstand shock, high G loading, sustained acceleration.
Reduced ringdown time	Mobile radio equipment, data transmission systems, narrow band applications.	Higher data rates, better performance in presence of impulse noise.

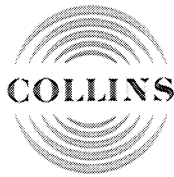

MECHANICAL FILTER FINDER

CASE TYPES

C
X
E
F
FA
J
K
Y
L
C
X
Y

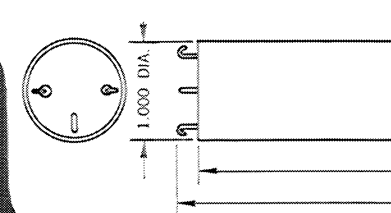
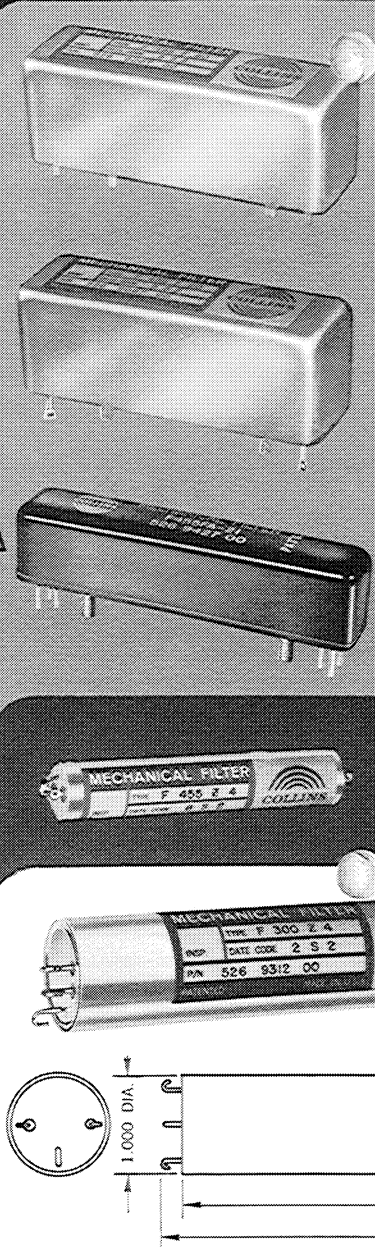

Y SERIES

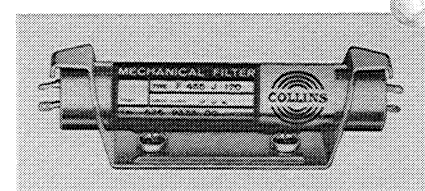

Center Freq.	Type No.	Part No.	6 db Bandwidth	Max. 60 db Bandwidth	Case Style
250 kc	F250A-20	526-9012-00	2.0 kc	4.3 kc	C
250 kc	F250A-67	526-9039-00	6.7 kc	14.0 kc	C
250 kc	F250A-85	526-9049-00	8.5 kc	18.0 kc	C
300 kc	F300Y-68	526-9307-00	6.8 kc	13.2 kc	X
455 kc	F455E-05	526-9321-00	0.5 kc	2.5 kc	E
455 kc	F455F-05	526-9318-00	0.5 kc	2.5 kc	F
455 kc	F455H-05	526-9229-00	0.5 kc	2.5 kc	H
455 kc	F455J-05	526-9154-00	0.5 kc	2.5 kc	J
455 kc	F455K-05	526-9228-00	0.5 kc	2.5 kc	K
455 kc	F455E-15	526-9370-00	1.5 kc	3.5 kc	E
455 kc	F455F-15	526-9227-00	1.5 kc	3.5 kc	F
455 kc	F455H-15	526-9170-00	1.5 kc	3.5 kc	H
455 kc	F455J-15	526-9135-00	1.5 kc	3.5 kc	J
455 kc	F455K-15	526-9168-00	1.5 kc	3.5 kc	K
455 kc	F455E-21	526-9322-00	2.1 kc	5.3 kc	E
455 kc	F455F-21	526-9323-00	2.1 kc	5.3 kc	F
455 kc	F455H-21	526-9313-00	2.1 kc	5.3 kc	H
455 kc	F455J-21	526-9156-00	2.1 kc	5.3 kc	J
455 kc	F455K-21	526-9317-00	2.1 kc	5.3 kc	K
455 kc	F455Y-21	526-9337-00	2.1 kc	5.3 kc	Y
455 kc	F455FA-21	526-9427-00	2.1 kc	5.3 kc	FA
455 kc	F455E-31	526-9074-00	3.1 kc	6.5 kc	E
455 kc	F455F-31	526-9075-00	3.1 kc	6.5 kc	F
455 kc	F455H-31	526-9093-00	3.1 kc	6.5 kc	H
455 kc	F455J-31	526-9089-00	3.1 kc	6.5 kc	J
455 kc	F455K-31	526-9169-00	3.1 kc	6.5 kc	K
455 kc	F455Y-31	526-9338-00	3.1 kc	6.5 kc	Y
455 kc	F455E-40	526-9324-00	4.0 kc	8.5 kc	E
455 kc	F455F-40	526-9325-00	4.0 kc	8.5 kc	F
455 kc	F455H-40	526-9326-00	4.0 kc	8.5 kc	H
455 kc	F455J-40	526-9327-00	4.0 kc	8.5 kc	J
455 kc	F455K-40	526-9303-00	4.0 kc	8.5 kc	K
455 kc	F455Y-40	526-9339-00	4.0 kc	8.5 kc	Y
455 kc	F455E-60	526-9084-00	6.0 kc	12.6 kc	E
455 kc	F455F-60	526-9087-00	6.0 kc	12.6 kc	F
455 kc	F455H-60	526-9094-00	6.0 kc	12.6 kc	H
455 kc	F455J-60	526-9091-00	6.0 kc	12.6 kc	J
455 kc	F455K-60	526-9159-00	6.0 kc	12.6 kc	K
455 kc	F455Y-60	526-9340-00	6.0 kc	12.6 kc	Y
455 kc	F455E-80	526-9332-00	8.0 kc	18.5 kc	E
455 kc	F455F-80	526-9331-00	8.0 kc	18.5 kc	F
455 kc	F455H-80	526-9330-00	8.0 kc	18.5 kc	H
455 kc	F455J-80	526-9329-00	8.0 kc	18.5 kc	J
455 kc	F455K-80	526-9328-00	8.0 kc	18.5 kc	K
455 kc	F455Y-80	526-9341-00	8.0 kc	18.5 kc	Y
455 kc	F455E-120	526-9336-00	12.0 kc	23.0 kc	E
455 kc	F455F-120	526-9173-00	12.0 kc	23.0 kc	F
455 kc	F455H-120	526-9171-00	12.0 kc	23.0 kc	H
455 kc	F455J-120	526-9333-00	12.0 kc	23.0 kc	J
455 kc	F455K-120	526-9316-00	12.0 kc	23.0 kc	K
455 kc	F455Y-120	526-9342-00	12.0 kc	23.0 kc	Y
455 kc	F455E-160	526-9320-00	16.0 kc	27.5 kc	E
455 kc	F455F-160	526-9335-00	16.0 kc	27.5 kc	F
455 kc	F455H-160	526-9314-00	16.0 kc	27.5 kc	H
455 kc	F455J-160	526-9334-00	16.0 kc	27.5 kc	J
455 kc	F455K-160	526-9315-00	16.0 kc	27.5 kc	K
455 kc	F455Y-160	526-9343-00	16.0 kc	27.5 kc	Y
455 kc	F455E-350	526-9371-00	35.0 kc	62.0 kc	E
455 kc	F455F-350	526-9180-00	35.0 kc	62.0 kc	F
455 kc	F455H-350	526-9302-00	35.0 kc	62.0 kc	H
455 kc	F455J-350	526-9300-00	35.0 kc	62.0 kc	J
455 kc	F455K-350	526-9186-00	35.0 kc	62.0 kc	K
455 kc	F455Y-350	526-9344-00	35.0 kc	62.0 kc	Y
500 kc	F500B-08	526-9007-00	0.8 kc	3.5 kc	B
500 kc	F500B-14	526-9030-00	1.4 kc	3.8 kc	B
500 kc	F500F-14	526-9215-00	1.4 kc	3.5 kc	F
500 kc	F500B-31	526-9008-00	3.1 kc	7.5 kc	B
500 kc	F500B-60	526-9009-00	6.0 kc	14.0 kc	B
500 kc	F500F-60	526-9319-00	6.0 kc	19.0 kc	F
500 kc	F500Y-60	526-9378-100	6.0 kc	13.2 kc	Y

Carrier Freq.	Type No.	Part No.	Sideband	Case
64 kc	F64Z-7	526-9396-00	Lower Sideband	L
68 kc	F68Z-7	526-9397-00	" "	L
72 kc	F72Z-7	526-9398-00	" "	L
76 kc	F76Z-7	526-9399-00	" "	L
80 kc	F80Z-7	526-9400-00	" "	L
84 kc	F84Z-7	526-9401-00	" "	L
88 kc	F88Z-7	526-9402-00	" "	L
92 kc	F92Z-7	526-9403-00	" "	L
96 kc	F96Z-7	526-9404-00	" "	L
100 kc	F100Z-7	526-9405-00	" "	L
104 kc	F104Z-7	526-9406-00	" "	L
108 kc	F108Z-7	526-9407-00	" "	L
250 kc	F250Z-4	526-9130-00	Upper Sideband	C
250 kc	F250Z-5	526-9131-00	Lower Sideband	X
300 kc	F300Z-4	526-9312-00	Upper Sideband	C
300 kc	F300Z-5	526-9311-00	Lower Sideband	X
455 kc	F455Z-4	526-9364-00	Upper Sideband	Y (Long)
455 kc	F455Z-5	526-9365-00	Lower Sideband	Y (Long)
550 kc	F500Z-4	526-9377-00	Upper Sideband	Y (Standard)
550 kc	F500Z-5	526-9376-00	Lower Sideband	Y (Standard)

SINGLE SIDEBAND FILTERS

Mechanical Filters are available in a wide variety of case and mounting styles. The basic designs are shown on these pages; however, we will be pleased to discuss any special case configuration requirements you may have.

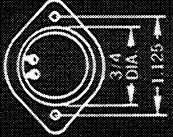
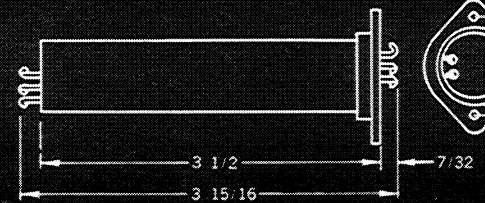
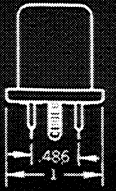
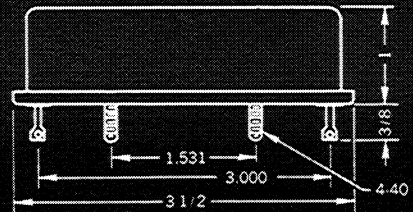
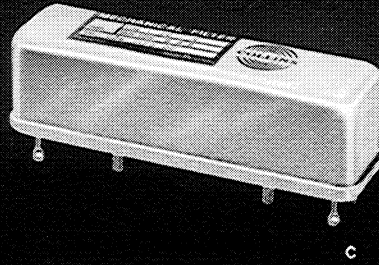
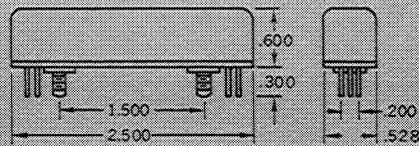
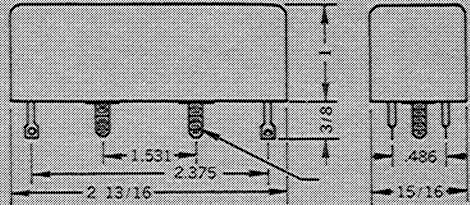
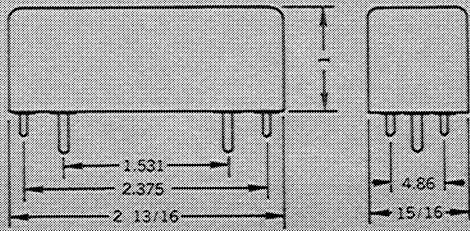

All dimensions in inches.

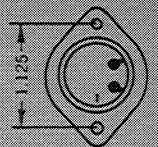
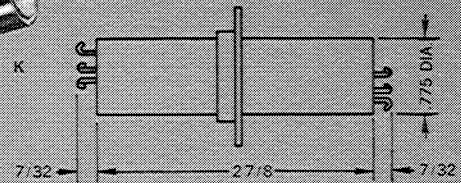
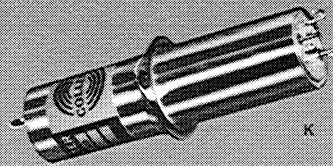
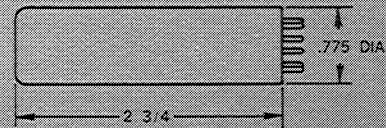
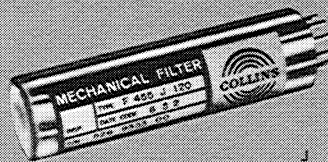
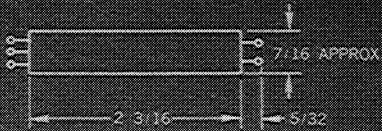

MOUNTINGS

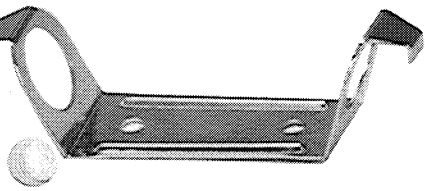

Flat Surface Mounting, 591-0613-002
For mounting on flat surface such as printed circuit board.
For standard Y series only.

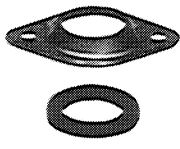

Feed Through, 591-0615-002
For mounting through chassis or shield partition. This method recommended.

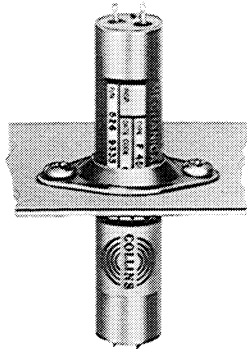

Tube Socket Adapter (Feed Through) 591-0617-002
For adapting standard bracket to existing tube socket hole pattern.

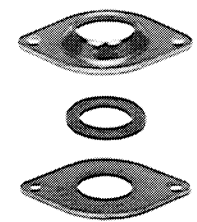

SELECTIVITY CHARACTERISTICS OF COLLINS MECHANICAL FILTERS

Shown on the following pages are typical selectivity characteristics of a number of standard production Filters. The curves indicate the actual performance to be expected from an average Filter.

Mechanical Filters, designed to meet environmental requirements of MIL-STD specs, are contained in small, hermetically-sealed brass cases finished with Type VI, Class 2 nickel plate in accordance with Federal Specification QQ-N-290. The Filters thus withstand humidity tests, corrosion resistance tests and operation at extreme altitudes. Interior construction is such that the Filters withstand vibration in accordance with MIL-STD-202A, Method 201A, and shock in accordance with MIL-STD-202A, Method 202A.

F250 SERIES

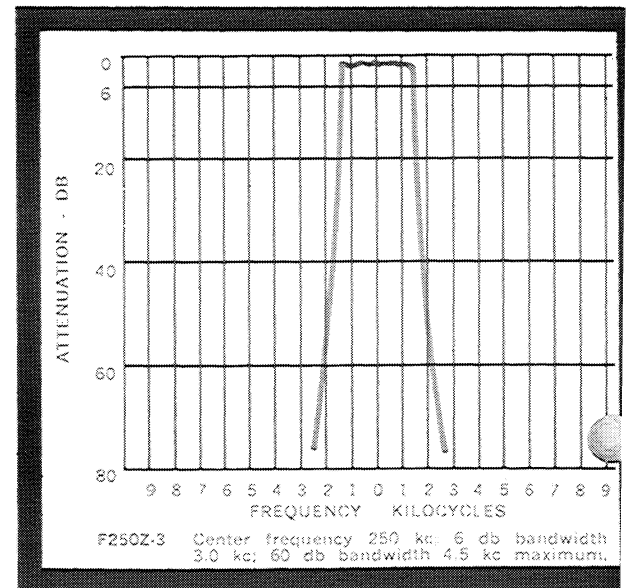
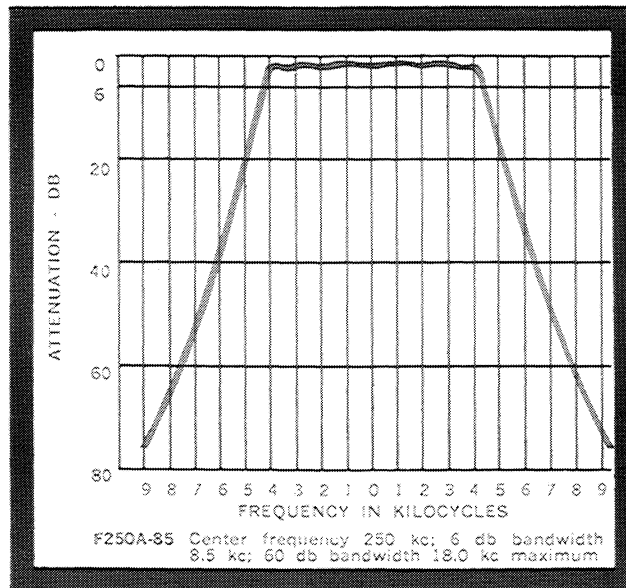
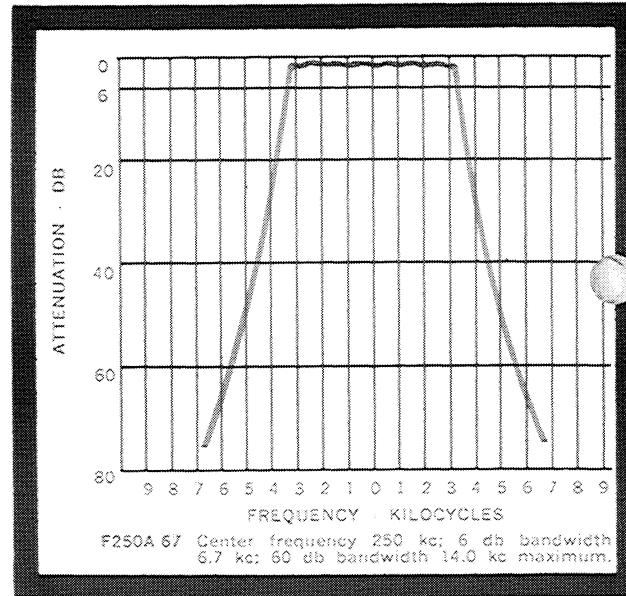
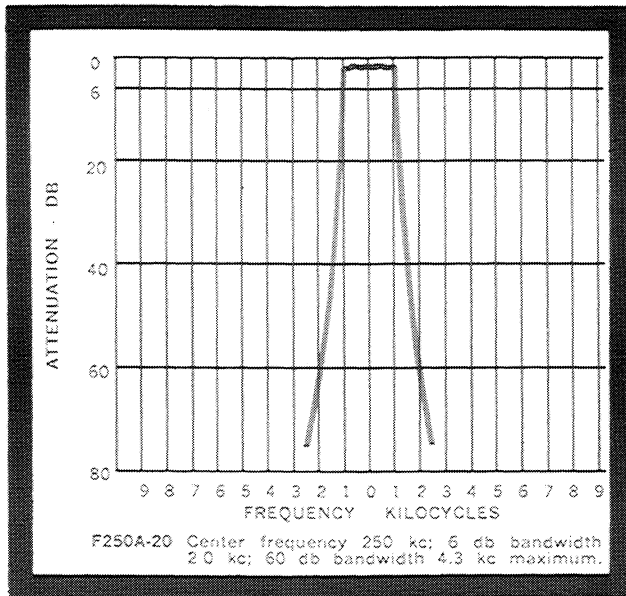

F300 SERIES

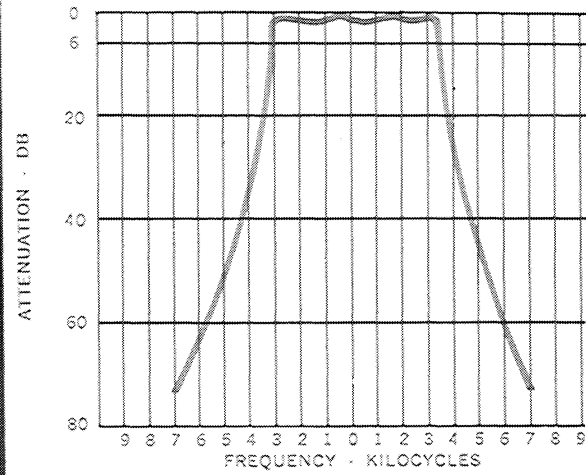

F300X-68 Center frequency 300 kc; 6 db bandwidth 6.8 kc; 60 db bandwidth 13.2 kc maximum.

F455 SERIES

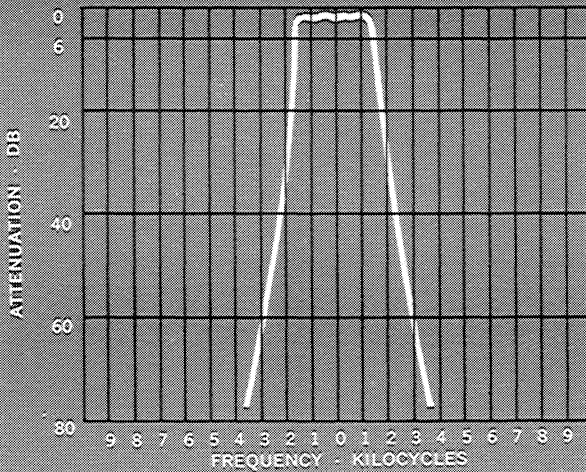

F455-21 Center frequency 455 kc; 6 db bandwidth 2.1 kc; 60 db bandwidth 5.3 kc maximum.

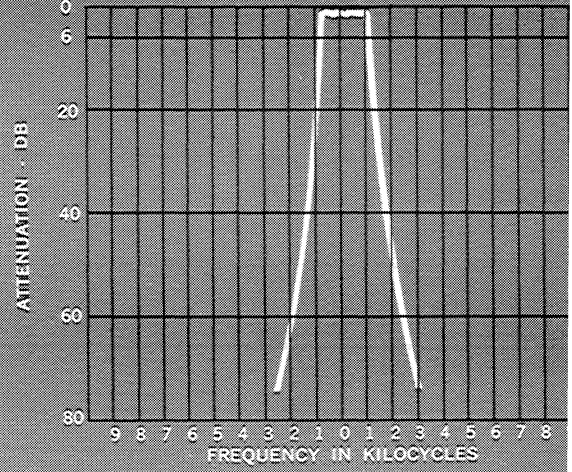

F455-31 Center frequency 455 kc; 6 db bandwidth 3.1 kc; 60 db bandwidth 6.5 kc maximum.

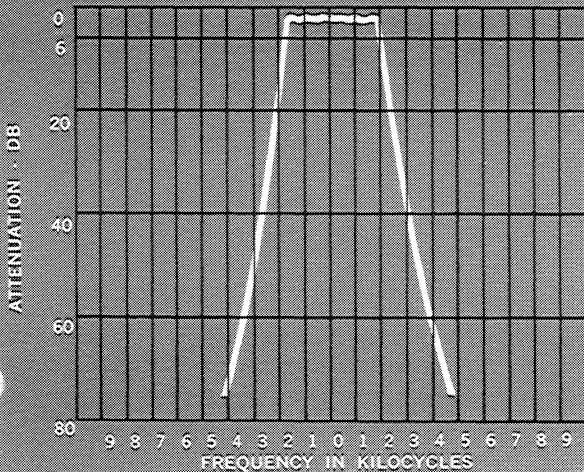

F455-40 Center frequency 455 kc; 6 db bandwidth 4.0 kc; 60 db bandwidth 8.5 kc maximum.

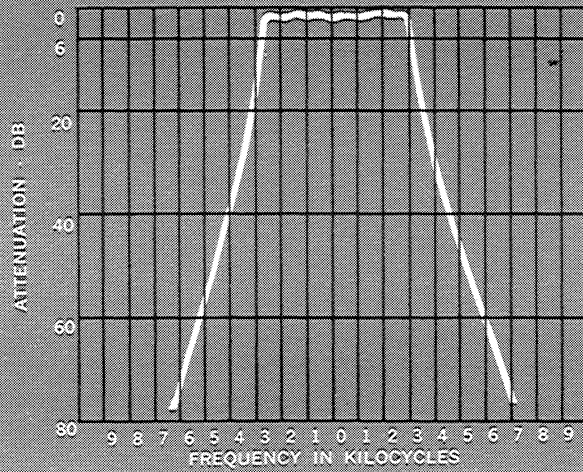

F455-60 Center frequency 455 kc; 6 db bandwidth 6.0 kc; 60 db bandwidth 12.6 kc maximum.

F455

F455

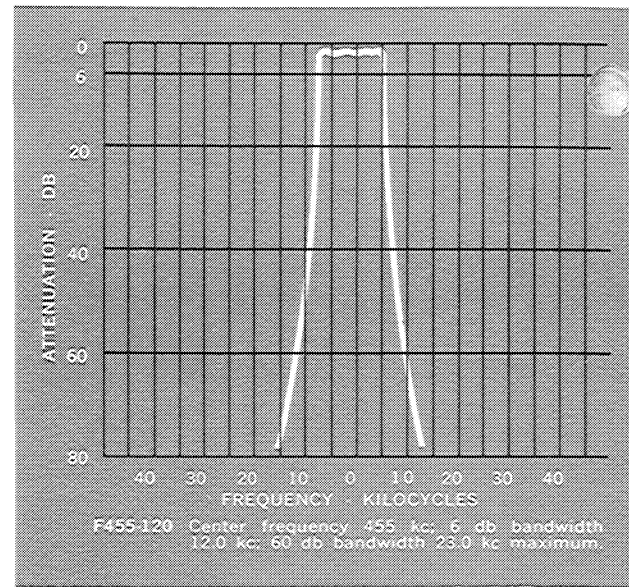
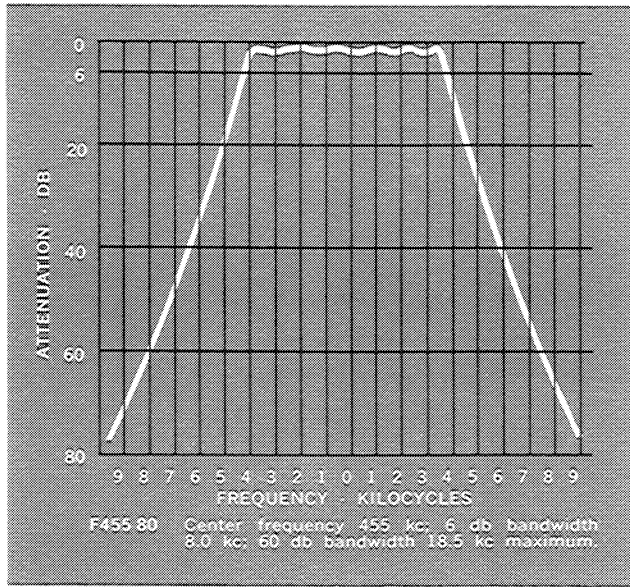

NOTE SCALE DIFFERENCES

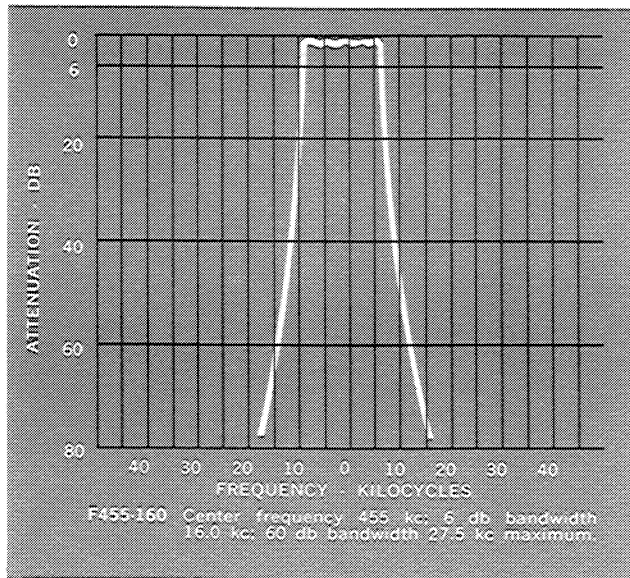

NOTE SCALE DIFFERENCES

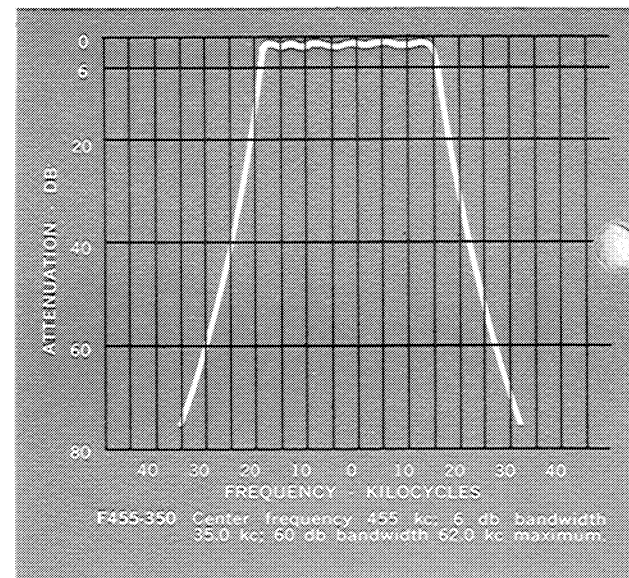

NOTE SCALE DIFFERENCES

"NARROW" F455 SERIES

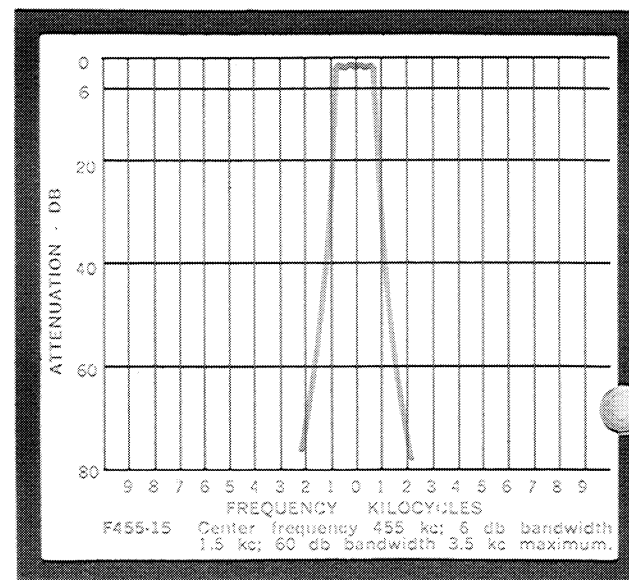
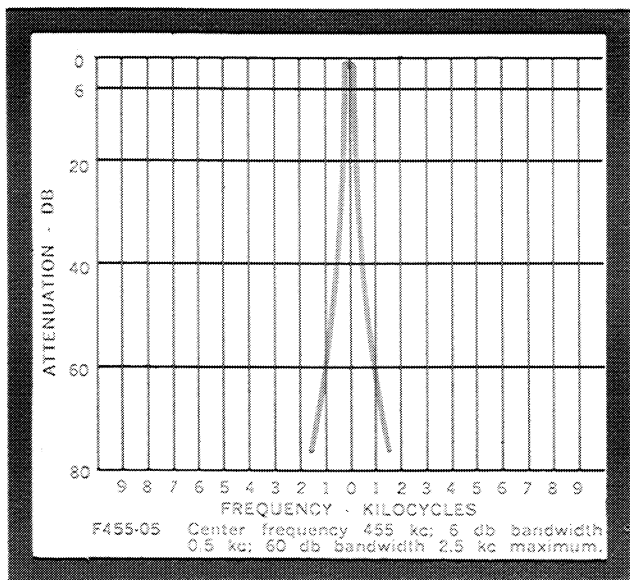

F500 SERIES

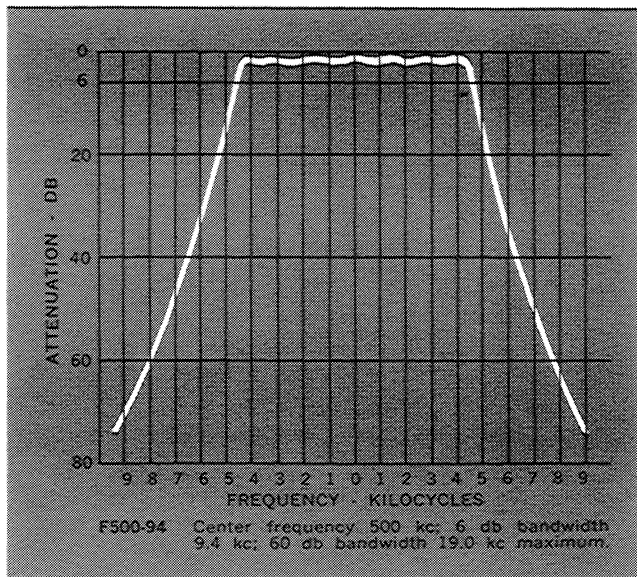
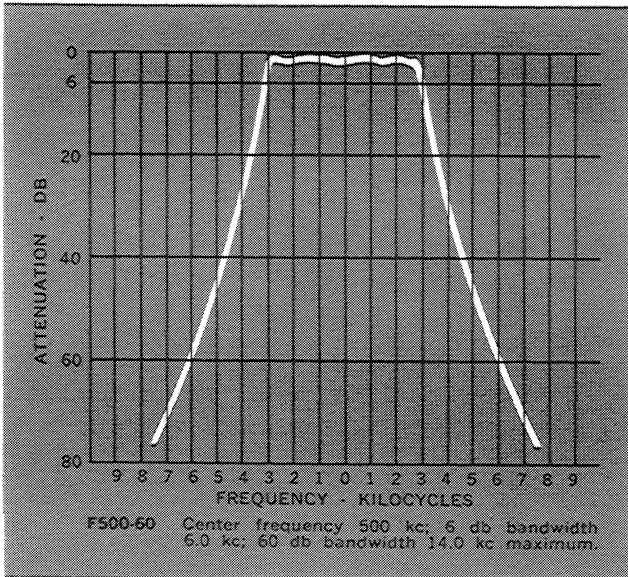
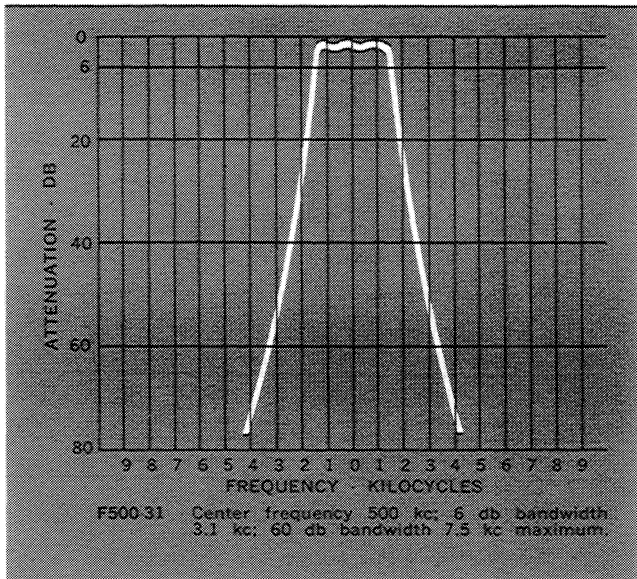
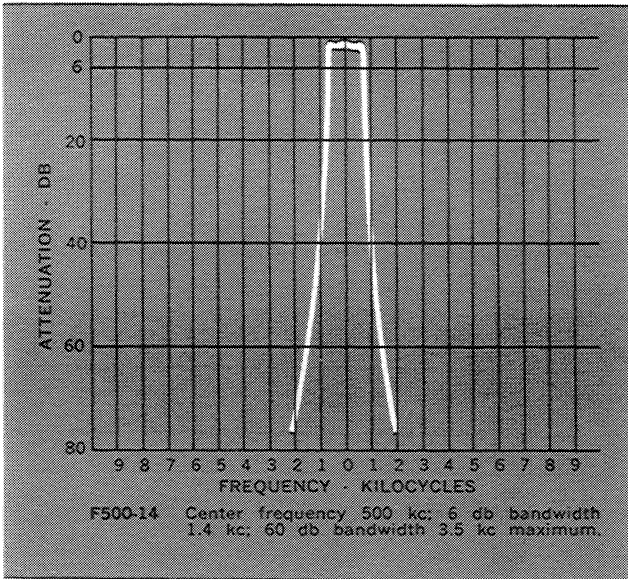
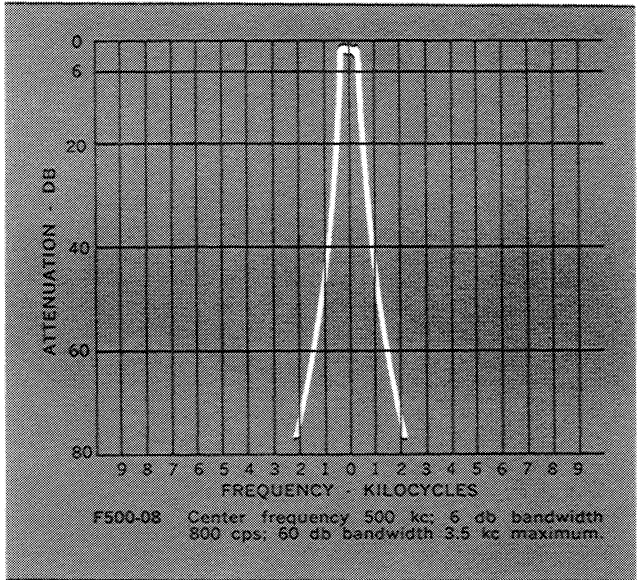

SSB 250 SERIES

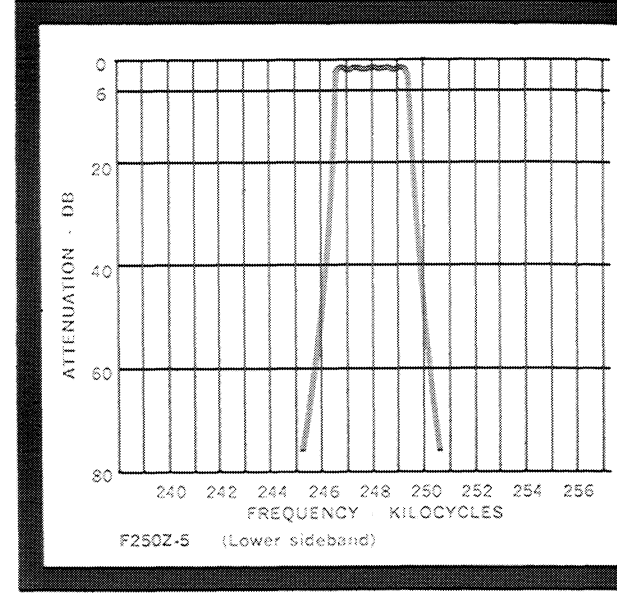
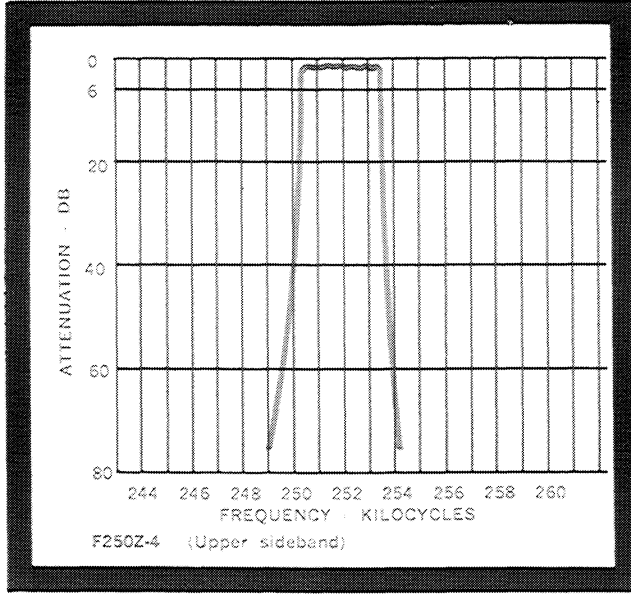

SSB 300 SERIES

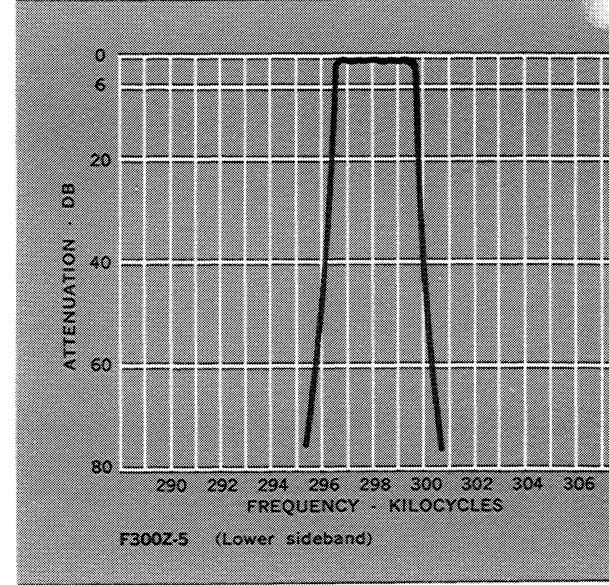
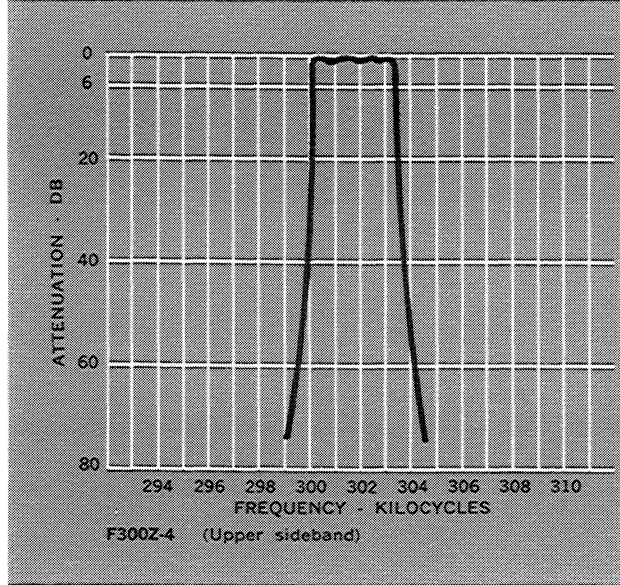

Filters will meet general performance requirements over the temperature range of -40°C to $+85^{\circ}\text{C}$ with the following maximum allowable deviation limits from the specified $+25^{\circ}\text{C}$ requirements:

Center Frequency	2 ppm/ $^{\circ}\text{C}$
Bandwidth	$\pm 5\%$
Peak-to-Valley Ratio	1 db increase
Transfer Impedance	$\pm 10\%$

Filters can be stored at temperatures from -65°C to $+100^{\circ}\text{C}$ without detrimental effects.

SSB 455 SERIES

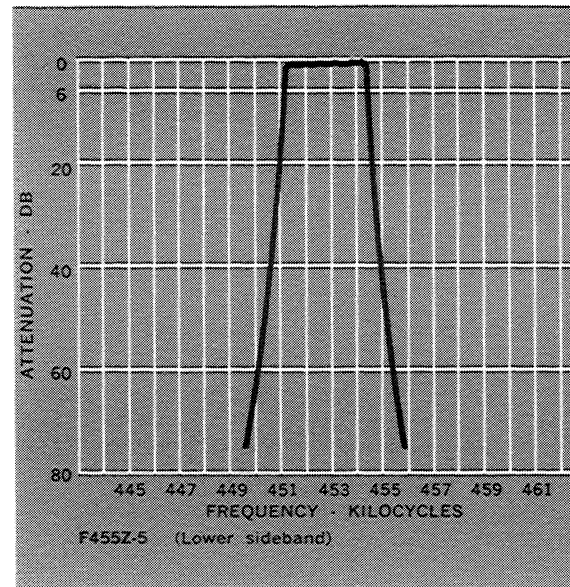
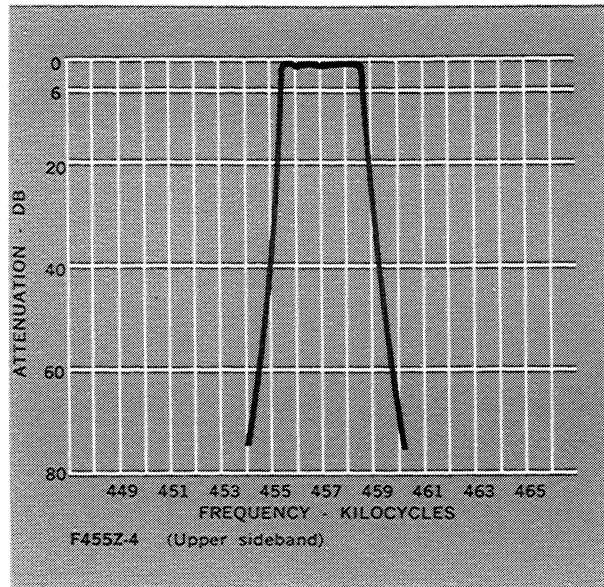

TYPICAL MECHANICAL FILTER SPECIFICATIONS

Detailed specifications available for all Filter types on request

Filter Type: F455Z-4

Description: Upper sideband selector for 455 kc carrier frequency

FREQUENCY RESPONSE

6 db Bandwidth	3.3 kc \pm 300 cps
60 db Bandwidth	.60 kc maximum
Peak-to-Valley Ratio	3 db maximum
Terminal Impedance	27 K ohms
Transfer Impedance	8.5 K ohms \pm 45%
Resonating Capacity	130 pf
Transmission Loss	10 db
Spurious Response	60 db minimum atten.

ADDITIONAL SELECTIVITY DATA

Frequency (KC)	Attenuation (db)
454.60	40 minimum
455.00	20 minimum
455.30	6 maximum
455.45	3 maximum
548.15	3 maximum
458.30	6 maximum

This Mechanical Filter is used to select only the upper sideband of a 455 kc amplitude modulated carrier, rejecting the carrier by at least 20 db and the lower sideband by at least 40 db.

In general, filter specifications call out minimum performance for all parameters; actual performance will exceed these minimums by a comfortable margin.

LOW COST MECHANICAL FILTER SERIES

A NEW FAMILY OF MECHANICAL FILTERS incorporating design and manufacturing innovations which lower prices as much as 25 percent has recently been introduced. A number of the new filters are already in production.

The new developments include four 455 kc center frequency filters with bandwidths of 800 cps, 2.1 kc, 2.7 kc and 12 kc and two 500 kc filters with bandwidths of 200 cps and 800 cps. All have the steep-skirted selectivity common to all Collins mechanical filters.

Packaged in a durable, high-impact phenolic case, the new filters should find wide use in commercial and amateur communications equipment, especially in single sideband transmitters and receivers. The narrow bandwidth filters are especially suited for cw and data service in receivers.

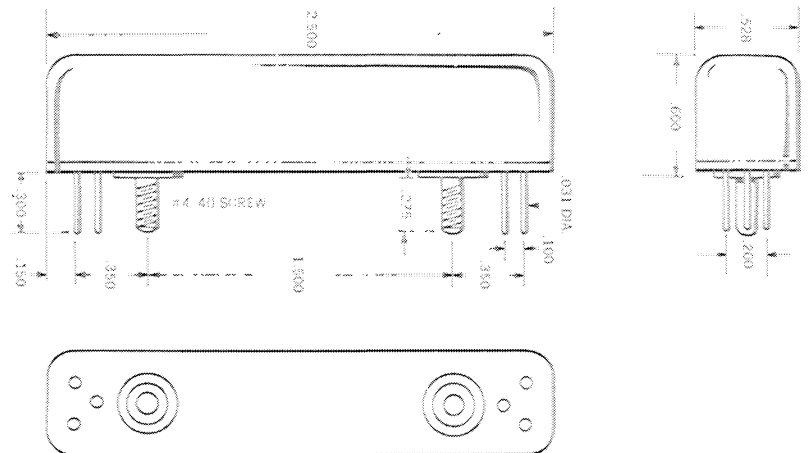
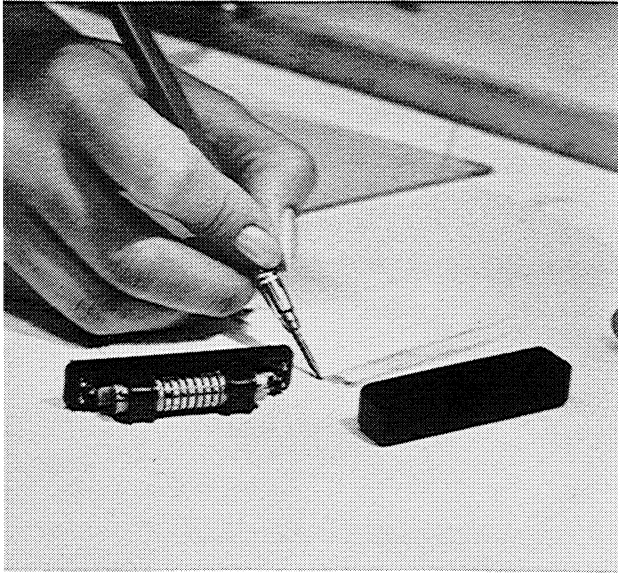

THE 455 KC FILTER WITH THE 12 KC BANDWIDTH is a newer version of a filter now being designed into FM mobile communication equipment and used for field modification of wideband FM mobile systems for split-channel operation.

Size of the new filters is $2\frac{1}{2}$ inches in length, and slightly more than $\frac{1}{2}$ inch wide and $\frac{1}{2}$ inch high, not including mounting lugs and terminals. They can be plugged into standard three-prong transistor sockets and are especially suited for circuit board manufacturing techniques involving dip soldering.

A SPECIAL VERSION OF THE 455 KC FILTER with the 2.1 kc bandwidth is available for use by amateur radio operators in constructing single sideband transmitters. In these filters, the frequency reading 20 db down each side of the individual filter's selectivity curve is specified on the filter label. This aids in selection of crystals of exactly the right frequency for use in generating transmitter carrier frequency.

Note: This drawing represents only the filters currently in production in this configuration. The same packaging can be applied to filters from 200 cps to 50kc.

SPECIFICATIONS

F455 FA-21 MECHANICAL FILTER

Center Frequency.....	455 kc nom.
Frequency Response	
Bandwidth, 6 db attenuation.....	2.1 kc nom.
Bandwidth, 60 db attenuation.....	5.3 kc max.
Passband Response Variation	3 db max.
Transfer Impedence.....	6.75K ohms \pm 2.25K ohms
Resonating Capacity	130 pf \pm 5pf
Transmission Loss	9.5 db
Spurious Response Attenuation (440kc to 470kc).....	60 db min.

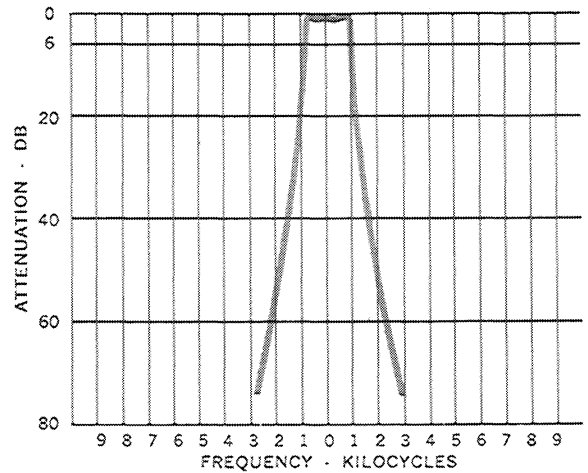
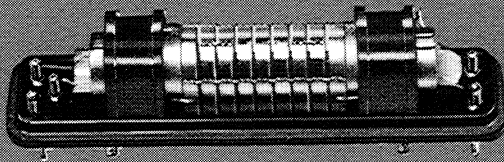

RECOMMENDED OPERATING PARAMETERS:

- Signal Input Voltage: 0 to 2 volts RMS.
- Direct Current: Shunt feed necessary to eliminate DC current in transducer coils. DC current in transducer coils will alter filter electrical characteristics.
- DC Voltages: 300 VDC max. potential between terminals and case.
- Signal Source and Load Impedance: Mechanical filters are normally used interstage.

ENVIRONMENTAL REQUIREMENTS:

- Operating Temperature Range: -40°C to $+85^{\circ}\text{C}$.
- Temperature Range, Non-Operating: -65°C to $+100^{\circ}\text{C}$.
- Vibration: Unit meets the performance requirements of MIL-STD-202B, Method 201A.
- Shock: Filter will withstand total of 18 impact shocks of 15G's in accordance with MIL-STD-202B, Method 202A.
- Moisture Resistance: Meets the performance requirements of ten day humidity test in accordance with MIL-STD-202B, Method 106A.
- Corrosion Resistance: Withstands salt spray in accordance with MIL-STD-202B, Method 101A, Test Condition B.

Specifications subject to change without notice.

VOICE MULTIPLEX MECHANICAL FILTER SERIES

A SERIES OF VOICE CHANNEL SELECTOR FILTERS for use in multiplex systems are available as standard items. These filters are designed for 4 kc channel spacing and operate as upper sideband selectors. There are 12 filters, side-by-side, starting from a low carrier frequency of 64 kc and going to a high carrier frequency of 108 kc.

A generalized curve is shown detailing typical selectivity of one of the filters in this series. The frequency scale shows carrier frequency as f_c . This value can be 64 kc, 68 kc and any 4 kc increment up to 108 kc. The other plot shows more clearly the relationship of each of the filters to the others in the series.

A series of filters such as this can be designed for upper or lower sideband selection within the 60 to 600 kc range.

Standard mechanical filters as listed in this catalog can be ordered directly from Collins Radio Company's Components Division or through any of its engineering representatives.

Most of the types listed are available for 60-90 days delivery, although large production orders are subject to negotiation.

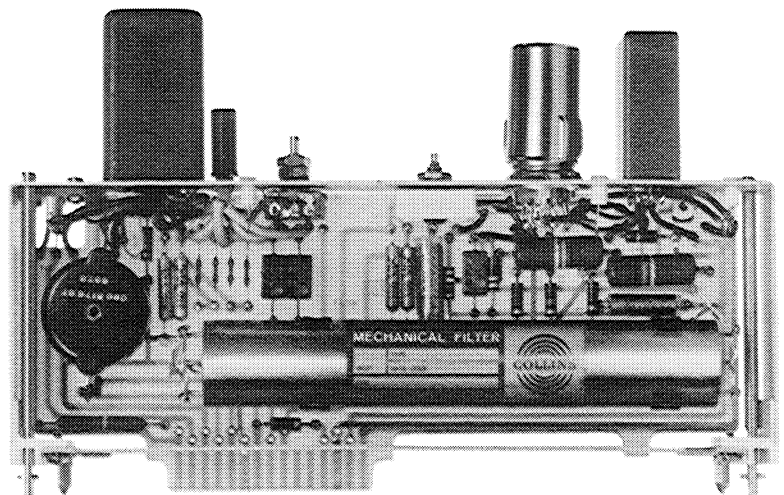
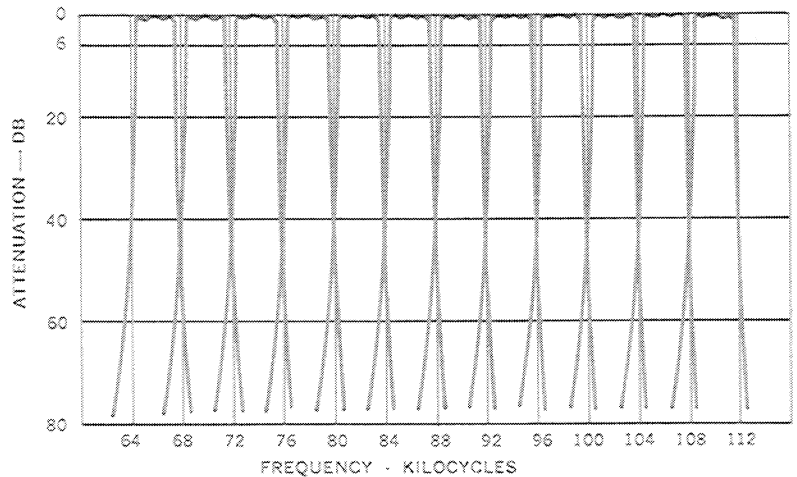
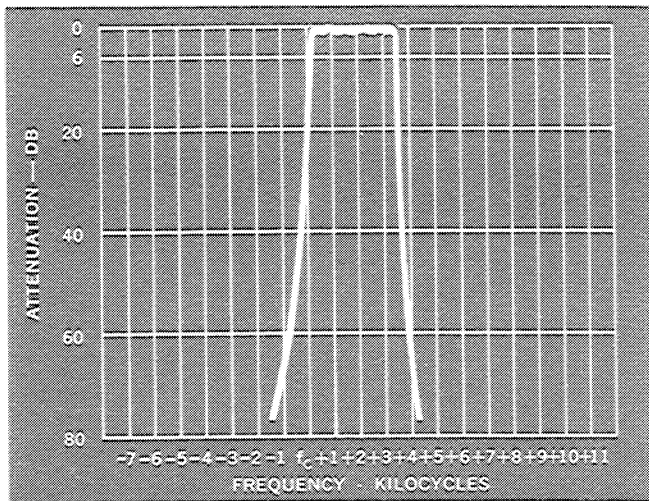

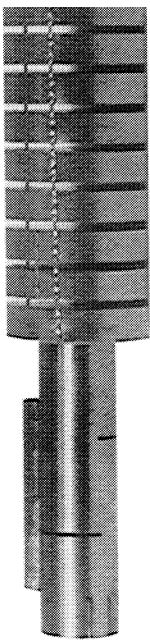

ORDERING INFORMATION

Price quotations will be furnished on request from Components Division Sales or any of the authorized engineering representatives.

Filters can be ordered by Type Number or Part Number, although ordering by Part Number is preferable. When ordering filters for individual use, any local sales tax should be added to the remittance, unless a tax exemption permit number can be supplied.

This catalog lists the standard production Mechanical Filters currently available. In addition, a large, experienced and capable engineering staff can design mechanical filters for applications requiring special characteristics. A filter application data sheet (Bulletin 1017) can serve as a guide in detailing the special requirements to be met and the special characteristics desired.

A word of caution regarding special designs: It will pay to make certain your requirements are not unnecessarily tight. A minor change in shape factor or passband ripple to match standard specifications may result in substantial cost savings.

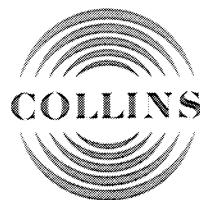

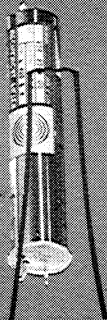

COLLINS RADIO COMPANY / 19700 San Joaquin Road / Newport Beach, California / Kimberly 9-2911
COLLINS RADIO COMPANY OF CANADA, LTD. / 150 Bartley Drive, Toronto 16, Ontario, Canada

These products available outside the U.S. from:
COLLINS RADIO COMPANY, International Division, P. O. Box 1891, Dallas 21, Texas